

# spirit.

la nuova generazione di pavimenti  
in doghe e piastrelle

PRESENTAZIONE NUOVA COLLEZIONE

**BERRY**  **ALLOC**®

# SPC: PAVIMENTI DI NUOVA GENERAZIONE



I pavimenti in SPC (Stone Polymer Composite) rappresentano l'evoluzione dei pavimenti vinilici in LVT.

La novità sta nella struttura rigida costruita con la tecnologia SPC che rende le tavole forti e stabili anche se sottoposte a forti sbalzi di temperatura, nonché maggiormente resistenti alla caduta di pesi ed all'usura.

Il nucleo centrale è composto da una miscela di carbonato di calcio (polvere di pietra) e stabilizzanti che rende il prodotto estremamente stabile e resistente.

Un pavimento in SPC è impermeabile al 100%, ha una notevole stabilità anche se esposto all'irraggiamento diretto del sole in prossimità di vetrate e non necessita di giunti di dilatazione se installato in grandi aree fino a 20x20 ml.

# COSTRUZIONE



Il finish protettivo e lo strato d'usura garantiscono una elevata resistenza all'usura, sia in contesti residenziali che commerciali. Il film decorativo può riprendere i decori del legno, riproducendone fedelmente la struttura delle venature, della pietra e del cemento ricreando una superficie assolutamente realistica.

La struttura in SPC, la vera rivoluzione di questa nuova tecnologia, offre straordinari vantaggi in termini di impermeabilità, stabilità e resistenza alla compressione.

Il materassino integrato rende il pavimento silenzioso riducendo di 20 dB il riverbero da calpestio.

# I VANTAGGI DI SPIRIT CLICK

Spirit, il nuovo pavimento in SPC di BerryAlloc, offre caratteristiche prestazionali decisamente superiori rispetto ai pavimenti vinilici tradizionali soprattutto riguardo i seguenti aspetti:



impermeabilità al 100%.

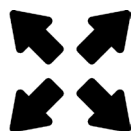

la particolare tecnologia costruttiva del prodotto conferisce maggiore stabilità dimensionale che permette di posizionare i giunti di dilatazione sia trasversalmente che longitudinalmente ogni 20 ml.

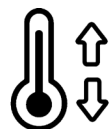

possibilità di posa in ambienti soggetti ad irraggiamento diretto del sole e con vetrate non protette da tendaggi o schermature



maggiore resistenza alla compressione ed ai carichi statici con la possibilità di posa anche su pavimenti ceramici con fughe fino ad 1 cm evitandone la rasatura



posa più veloce grazie alla maggior rigidità



## LA NUOVA COLLEZIONE SPIRIT



Pensata per spazi domestici e commerciali, la nuova generazione di pavimenti in vinile di BerryAlloc associa l'effetto materico del legno o della pietra naturale ad una superficie indistruttibile.

Resistenza e stabilità di Spirit si ottengono grazie alla struttura rigida composta da polveri minerali e vinile. Tale composizione, realizzata con tecniche produttive innovative, garantisce resistenza all'usura, alla caduta del peso, stabilità dimensionale e totale impermeabilità.

La collezione Spirit offre un'ampia gamma di pavimenti moderni e di alta qualità perfetti per ogni tipo di spazio, garantendo una lunga durata nel tempo anche in aree ad alto traffico. Per questo i pavimenti Spirit sono adatti sia a spazi domestici sia ad aree commerciali come hotel, uffici, ristoranti e negozi.

# PERCHÉ SCEGLIERE SPIRIT?



## COME VERO LEGNO.

Spirit coniuga l'aspetto e la sensazione dei materiali naturali con la praticità e la resistenza di un pavimento vinilico. Ecco perché le collezioni Pro e XL hanno la stessa struttura del legno. Motivi e texture in sintonia perfetta.



## FONOASSORBENTE

Ogni singola doga ad incastro del pavimento Spirit è dotata di materassino fonoassorbente integrato che riduce di 20 decibel il rumore da calpestio sul pavimento.



CHILD PROOF

## RESISTENTE ALLE SFIDE DELLA VITA QUOTIDIANA.

Scarpe sporche e bagnate, calpestio elevato, animali domestici, liquidi rovesciati, cibo calpestato: sono tutti imprevisti che non dovete temere perché abbiamo realizzato una superficie indistruttibile, facile da pulire e che non assorbe le macchie.



PET PROOF



WATER PROOF

## 100% RESISTENTE ALL'ACQUA

Il pavimento Spirit è 100% resistente all'acqua oltre ad essere indistruttibile e indeformabile.

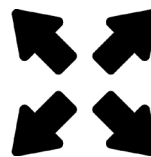

## TUTTA QUESTIONE DI STABILITÀ

L'innovativa tecnologia costruttiva e lo speciale trattamento delle doghe e delle piastrelle, garantiscono che il vostro pavimento mantenga sempre una superficie stabile, anche dopo ripetute variazioni di temperatura.



Phthalate Free



## 100% SENZA FTALATI

Spirit è un pavimento al 100% privo di ftalati che ha superato gli standard europei alzando l'asticella della qualità senza compromessi.

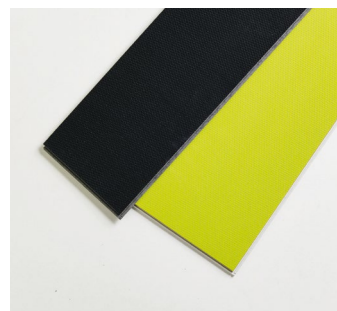

## FACILE DA INSTALLARE

Installare Spirit è facile e veloce. Posare il pavimento flottante in poco tempo è possibile grazie al pratico sistema ad incastro ad alta resistenza G2 o G5.

**2G 5G**

licensed by  
Vollinge

licensed by  
Vollinge

# LA GAMMA SPIRIT

## SPIRIT HOME

**GLUEDOWN 30**  
**CLICK 30**  
**CLICK COMFORT 40**

**PLANCE: 12 DECORI**  
**PIASTELLA: 6 DECORI**

## SPIRIT PRO

**PRO 55 GLUEDOWN**  
**PRO 55 CLICK COMFORT**

**PLANCE: 16 DECORI**  
**PIASTELLA: 10 DECORI**

## SPIRIT XL

**XL 55 GLUEDOWN**  
**XL 55 CLICK COMFORT**

**PLANCE: 8 DECORI**

# SPIRIT HOME - PLANCE

## GLUEDOWN 30 DA INCOLLARE

Strato d'usura 0,30 mm  
Spessore 2 mm  
1219 x 184 mm



## CLICK 30

Strato d'usura 0,3 mm  
Spessore 3,4 mm  
1210 x 176,6 mm



## CLICK COMFORT 40

Strato d'usura 0,40 mm  
Spessore 4 mm + 1 mm  
1210 x 176,6 mm

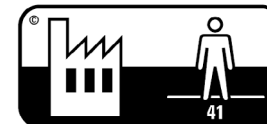

# 12 DECORI



# SPiRiT HOME - PLANCE



COSY NATURAL

gluedown 30 - **60001352**  
click 30 - **60001365**  
click comfort 40 - **60001412**



GRACE NATURAL

gluedown 30 - **60001349**  
click 30 - **60001362**  
click comfort 40 - **60001409**



LOFT NATURAL

gluedown 30 - **60001351**  
click 30 - **60001364**  
click comfort 40 - **60001411**



FRENCH LIGHT

gluedown 30 - **60001327**  
click 30 - **60001328**  
click comfort 40 - **60001401**



GRACE GREIGE

gluedown 30 - **60001350**  
click 30 - **60001363**  
click comfort 40 - **60001410**



FRENCH GREY

gluedown 30 - **60001342**  
click 30 - **60001355**  
click comfort 40 - **60001402**



PALMER NATURAL

gluedown 30 - **60001347**  
click 30 - **60001360**  
click comfort 40 - **60001407**



CANYON BROWN

gluedown 30 - **60001345**  
click 30 - **60001358**  
click comfort 40 - **60001405**



MOUNTAIN BROWN

gluedown 30 - **60001344**  
click 30 - **60001357**  
click comfort 40 - **60001404**



VINTAGE DARK

gluedown 30 - **60001346**  
click 30 - **60001359**  
click comfort 40 - **60001406**



PALMER CHOCOLATE

gluedown 30 - **60001348**  
click 30 - **60001361**  
click comfort 40 - **60001408**



FRENCH BLACK

gluedown 30 - **60001343**  
click 30 - **60001356**  
click comfort 40 - **60001403**

# SPIRIT HOME - PIASTRELLE



## GLUEDOWN 30 DA INCOLLARE

Strato d'usura 0,3 mm  
Spessore 2 mm  
914,4 x 609,6 mm

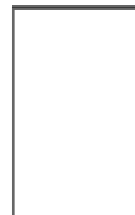

## CLICK COMFORT 40

Strato d'usura 0,4 mm  
Spessore 4,5 mm + 1 mm  
914 x 610 mm

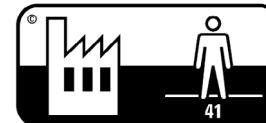
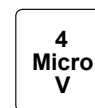

## 6 DECORI

# SPIRIT HOME - PIASTRELLE



CONCRETE WHITE GREY  
gluedown 30 - **60001423**  
click comfort 40 - **60001417**



CONCRETE BEIGE  
gluedown 30 - **60001421**  
click comfort 40 - **60001415**

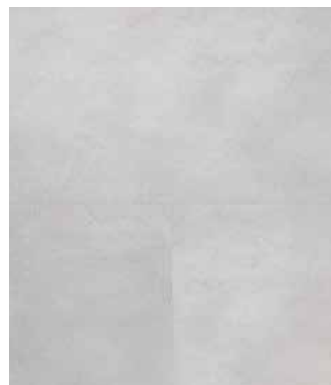

CONCRETE GREIGE  
gluedown 30 - **60001420**  
click comfort 40 - **60001414**



CONCRETE LIGHT GREY  
gluedown 30 - **60001422**  
click comfort 40 - **60001416**



CONCRETE GREY  
gluedown 30 - **60001419**  
click comfort 40 - **60001413**



CONCRETE DARK GREY  
gluedown 30 - **60001424**  
click comfort 40 - **60001418**

# SPIRIT PRO - PLANCE

## PRO 55 GLUEDOWN DA INCOLLARE

Strato d'usura 0,55 mm  
Spessore 2,50 mm  
1520 x 237 mm

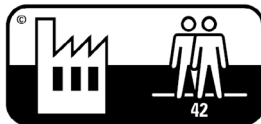

## PRO 55 CLICK COMFORT

Strato d'usura 0,55 mm  
Spessore 4,50 mm + 1 mm  
1511 x 228 mm

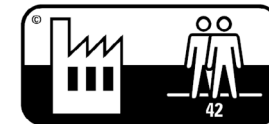
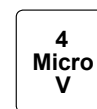

# 16 DECORI

# SPiRiT PRo - PLANCE



COUNTRY WHITE GREY  
gluedown 55 - **60001466**  
click comfort 55 - **60001434**



ELITE BEIGE  
gluedown 55 - **60001457**  
click comfort 55 - **60001425**



COUNTRY BEIGE  
gluedown 55 - **60001469**  
click comfort 55 - **60001437**



ELITE GREIGE  
gluedown 55 - **60001458**  
click comfort 55 - **60001426**



ELITE NATURAL  
gluedown 55 - **60001464**  
click comfort 55 - **60001432**



ELITE SAND  
gluedown 55 - **60001461**  
click comfort 55 - **60001429**



COUNTRY HONEY  
gluedown 55 - **60001465**  
click comfort 55 - **60001433**



ELITE HONEY  
gluedown 55 - **60001459**  
click comfort 55 - **60001427**



COUNTRY CARAMEL  
gluedown 55 - **60001468**  
click comfort 55 - **60001436**



COUNTRY MOKKA  
gluedown 55 - **60001467**  
click comfort 55 - **60001435**



COUNTRY SMOKED  
gluedown 55 - **60001471**  
click comfort 55 - **60001439**



ELITE TAUPE  
gluedown 55 - **60001460**  
click comfort 55 - **60001428**



ELITE BROWN  
gluedown 55 - **60001463**  
click comfort 55 - **60001431**



COUNTRY BROWN  
gluedown 55 - **60001470**  
click comfort 55 - **60001438**



ELITE DARK BROWN  
gluedown 55 - **60001462**  
click comfort 55 - **60001430**



COUNTRY DARK BROWN  
gluedown 55 - **60001472**  
click comfort 55 - **60001440**



# SPIRIT PRO - PIASTRELLE



## GLUEDOWN 55 DA INCOLLARE

Strato d'usura 0,55 mm  
Spessore 2,5 mm  
914,4 x 609,6 mm

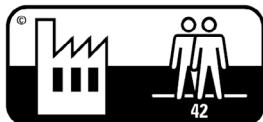

## CLICK COMFORT 55

Strato d'usura 0,55 mm  
Spessore 4,50 mm + 1 mm  
914 x 610 mm

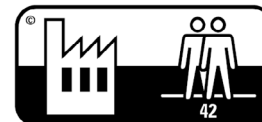
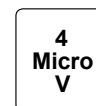

# 10 DECORI

# SPIRIT PRO - PIASTRELLE



MINERAL BEIGE  
gluedown 55 - **60001484**  
click comfort 55 - **60001474**



MINERAL GREY  
gluedown 55 - **60001483**  
click comfort 55 - **60001473**



CEMENT WHITE GREY  
gluedown 55 - **60001489**  
click comfort 55 - **60001479**

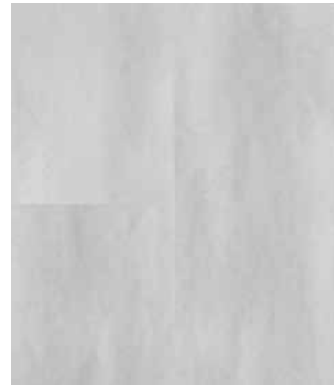

CEMENT LIGHT GREY  
gluedown 55 - **60001490**  
click comfort 55 - **60001480**



CEMENT TAUPE  
gluedown 55 - **60001492**  
click comfort 55 - **60001482**



VULCANO GREIGE  
gluedown 55 - **60001485**  
click comfort 55 - **60001475**



VULCANO GREY  
gluedown 55 - **60001487**  
click comfort 55 - **60001477**



CEMENT GREY  
gluedown 55 - **60001491**  
click comfort 55 - **60001481**



VULCANO DARK GREY  
gluedown 55 - **60001486**  
click comfort 55 - **60001476**



VULCANO BLACK  
gluedown 55 - **60001488**  
click comfort 55 - **60001478**

# SPIRIT XL - PLANCE

## XL 55 GLUEDOWN DA INCOLLARE

Strato d'usura 0,55 mm  
Spessore 2,5 mm  
1840 x 237 mm

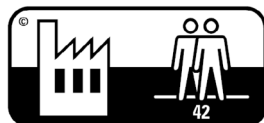

## XL 55 CLICK COMFORT

Strato d'usura 0,55 mm  
Spessore 4,5 mm + 1 mm  
1830 x 228 mm

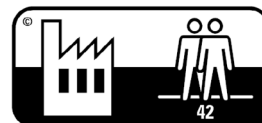

# 8 DECORI

# SPiRiT XL - PLANCE



YOSEMITE

gluedown 55 - **60001448**  
click comfort 55 - **60001456**



FITZ ROY

gluedown 55 - **60001444**  
click comfort 55 - **60001452**



LONG RANGE

gluedown 55 - **60001445**  
click comfort 55 - **60001453**



KINGS CANYON

gluedown 55 - **60001442**  
click comfort 55 - **60001450**



SIERRA HIGH

gluedown 55 - **60001446**  
click comfort 55 - **60001454**



INCA

gluedown 55 - **60001441**  
click comfort 55 - **60001449**



PACIFIC CREST

gluedown 55 - **60001443**  
click comfort 55 - **60001451**



BAY OF FIRES

gluedown 55 - **60001447**  
click comfort 55 - **60001455**

# INSTALLAZIONE GLUEDOWN

## 1 - PREPARAZIONE

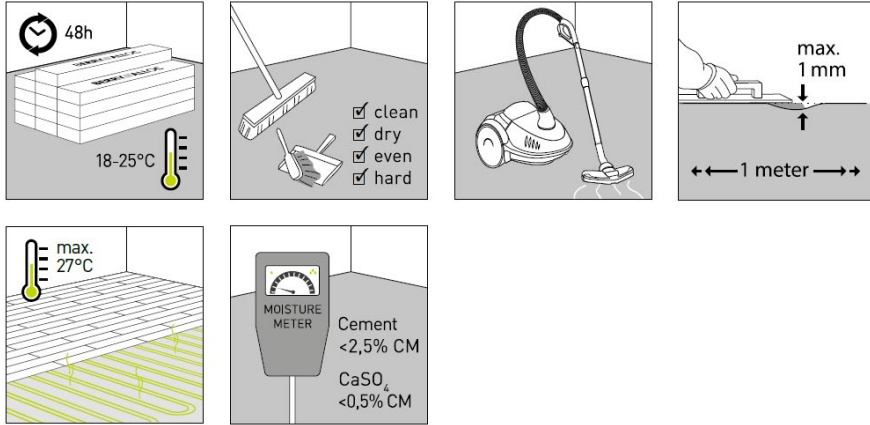

## 2 - INSTALLAZIONE

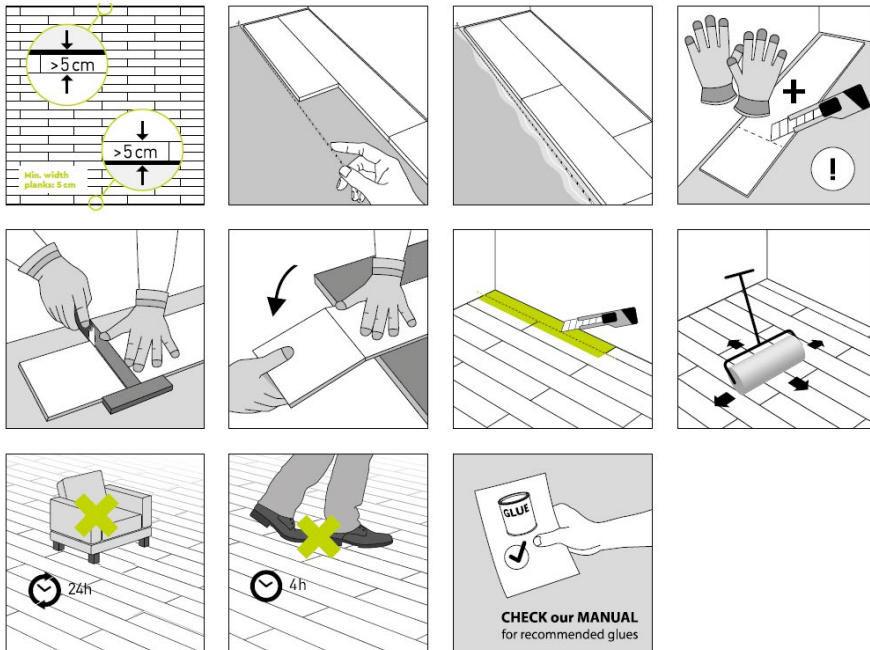

## 3 - FINITURE

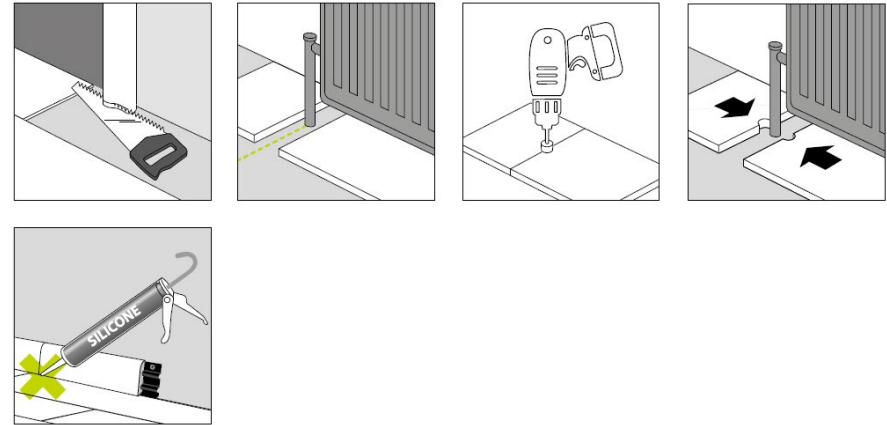

## 4 - MANUTENZIONE

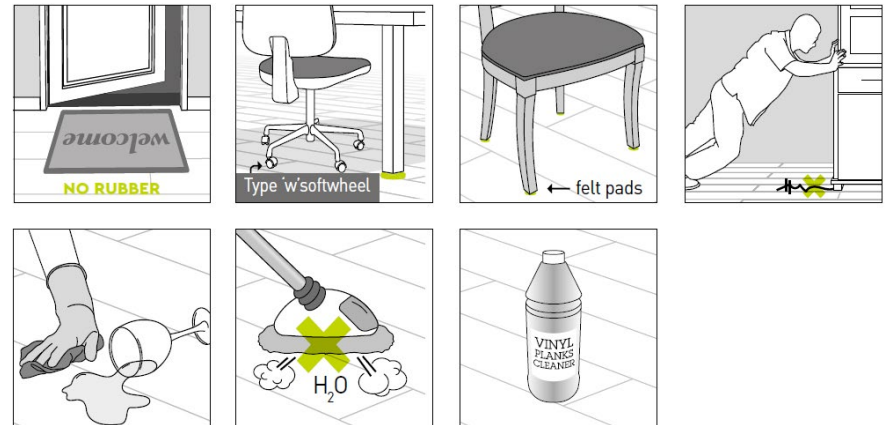



# INSTALLAZIONE CLICK



## 1 - PREPARAZIONE

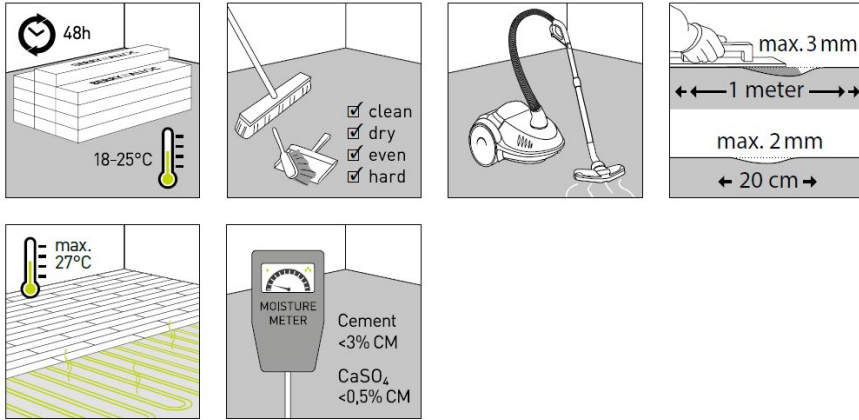

## 2 - INSTALLAZIONE

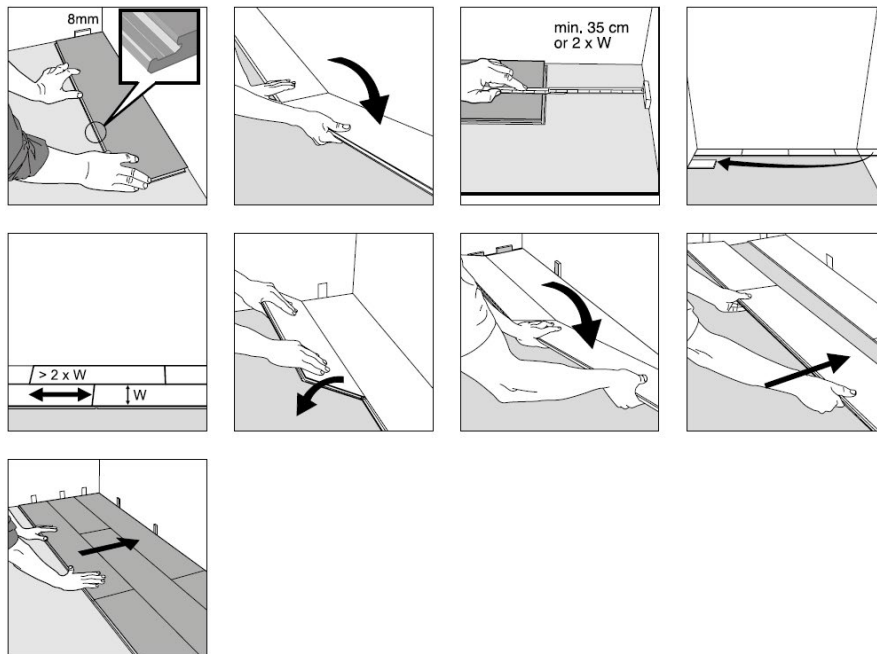

## 3 - FINITURE

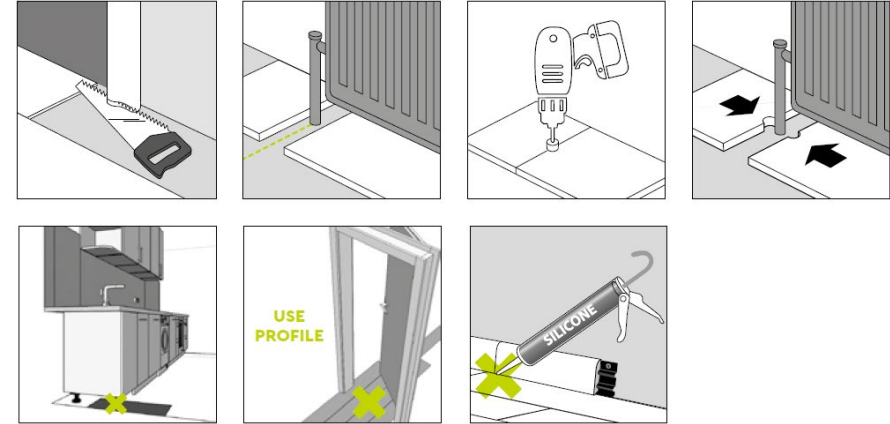

## 4 - MANUTENZIONE

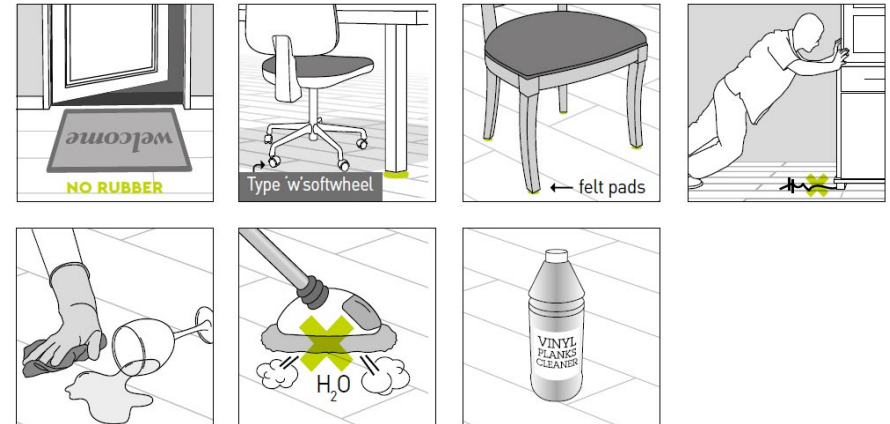

# INSTALLAZIONE CLICK

5G

licensed by Valinge

## 1 - PREPARAZIONE

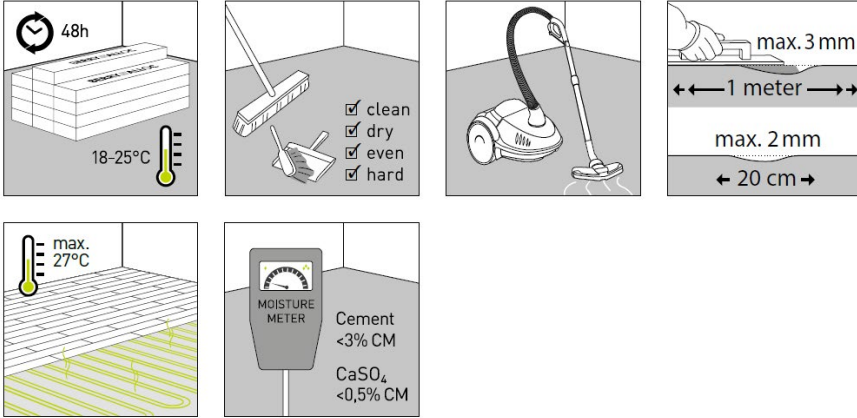

## 2 - INSTALLAZIONE

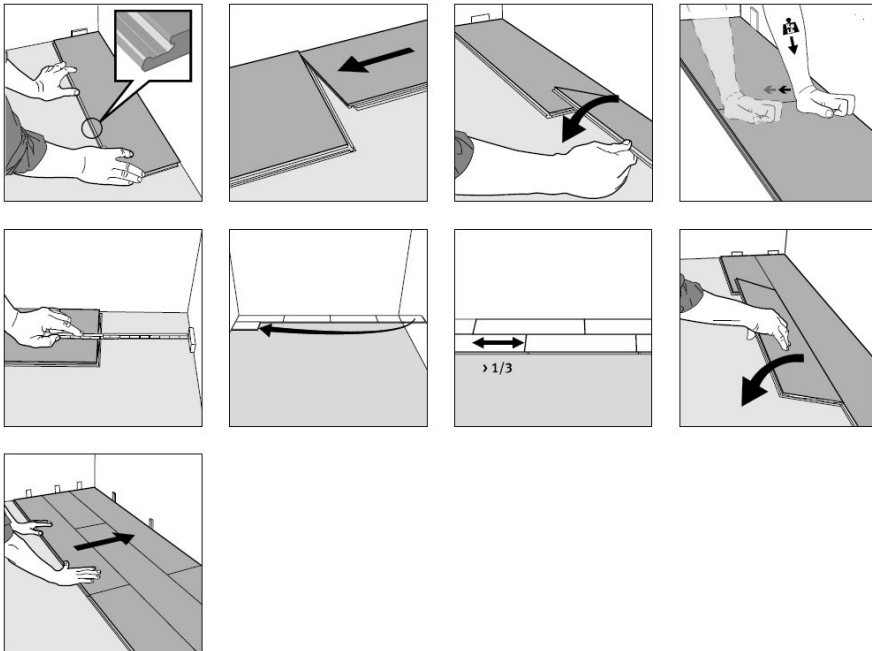

## 3 - FINITURE

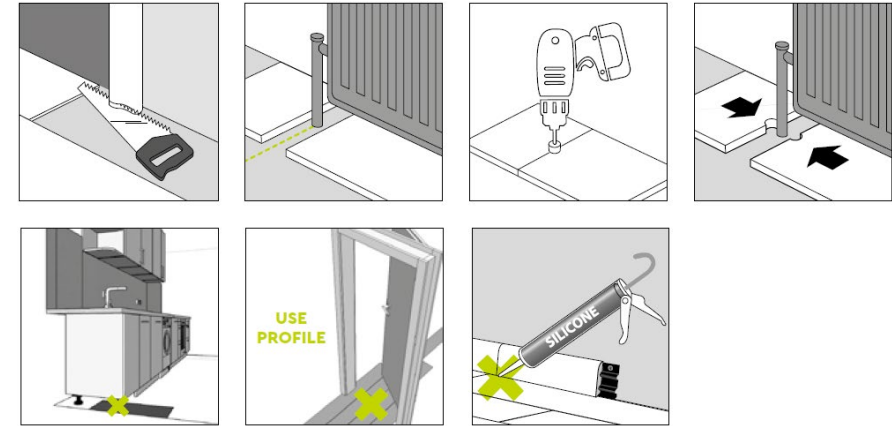

## 4 - MANUTENZIONE

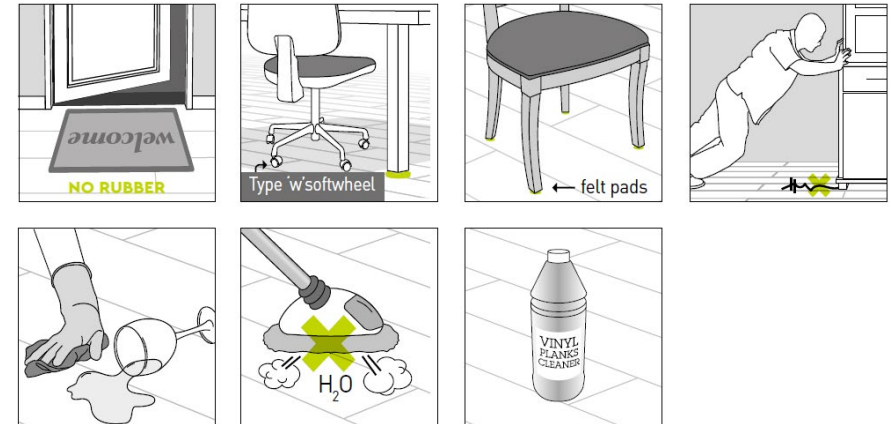

# ACCESSORI

## MATERASSINI

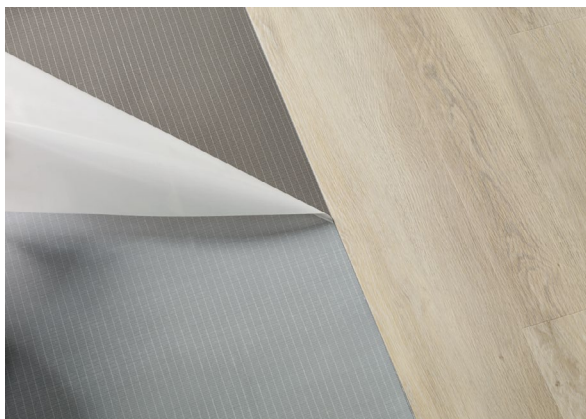

**FastTec 63000903**



**DreamTec: 63000027**

## PROFILI IN ALLUMINIO



**Profilo a T in alluminio**  
argento - 63000576  
bronzo - 63000578  
champagne - 63000577



**Profilo di raccordo in alluminio**  
argento - 63000573  
bronzo - 63000575  
champagne - 63000574



**profilo terminale in alluminio**  
argento - 63000579  
bronzo - 63000581  
champagne - 63000580

# ACCESSORI COORDINATI

## BATTISCOPA IMPERMEABILE

60 x 12 x 2400

## PROFILO A T

Per pacco  
(4 pezzi)

Per pezzo

FRENCH LIGHT	63002243	63002300
FRENCH GREY	63002245	63002301
FRENCH BLACK	63002246	63002302
MOUNTAIN BROWN	63002247	63002303
CANYON BROWN	63002248	63002304
VINTAGE DARK	63002249	63002305
PALMER NATURAL	63002250	63002306
PALMER CHOCOLATE	63002251	63002307
GRACE NATURAL	63002252	63002308
GRACE GREIGE	63002253	63002309
LOFT NATURAL	63002254	63002310
COSY NATURAL	63002255	63002311
CONCRETE GREY	63002256	63002312
CONCRETE GREIGE	63002257	63002313
CONCRETE BEIGE	63002258	63002314
CONCRETE LIGHT GREY	63002259	63002315
CONCRETE WHITE GREY	63002260	63002316
CONCRETE DARK GREY	63002261	63002317
ELITE BEIGE	63002262	63002318
ELITE GREIGE	63002263	63002319
ELITE HONEY	63002264	63002320
ELITE TAUPE	63002265	63002321
ELITE SAND	63002266	63002322
ELITE DARK BROWN	63002267	63002323
ELITE BROWN	63002268	63002324
ELITE NATURAL	63002269	63002325

## BATTISCOPA IMPERMEABILE

60 x 12 x 2400

## PROFILO A T

Per pacco  
(4 pezzi)

Per pezzo

COUNTRY HONEY	63002270	63002326
COUNTRY WHITE GREY	63002271	63002327
COUNTRY MOKKA	63002272	63002328
COUNTRY CARAMEL	63002273	63002329
COUNTRY BEIGE	63002274	63002330
COUNTRY BROWN	63002275	63002331
COUNTRY SMOKED	63002276	63002332
COUNTRY DARK BROWN	63002277	63002333
MINERAL GREY	63002278	63002334
MINERAL BEIGE	63002279	63002335
VULCANO GREIGE	63002280	63002336
VULCANO DARK GREY	63002281	63002337
VULCANO GREY	63002282	63002338
VULCANO BLACK	63002283	63002339
CEMENT WHITE GREY	63002284	63002340
CEMENT LIGHT GREY	63002285	63002341
CEMENT GREY	63002286	63002342
CEMENT TAUPE	63002287	63002343
INCA	63002288	63002344
KINGS CANYON	63002289	63002345
PACIFIC CREST	63002290	63002346
FITZ ROY	63002291	63002347
LONG RANGE	63002292	63002348
SIERRA HIGH	63002293	63002349
BAY OF FIRES	63002294	63002350
YOSEMITE	63002295	63002351



**Battiscopa coordinato**



**Profilo a T coordinato**

# PRODOTTI DI MANUTENZIONE



**Detergente: 63000772**



**PU Protector: 63000773**



# STRUMENTI DI MARKETING



LEAFLET



BROCHURE



BOX PORTACAMPIONI



MAZZETTE

- Spirit Home Planks
- Spirit Home Tiles
- Spirit Pro Planks
- Spirit Pro Tiles
- Spirit XL

# STRUMENTI DI MARKETING



## ESPOSITORE SPIRIT HOME

12 plance

6 piastrelle

Costo: 320 euro

Dimensioni: 1540 x 2008 x 531 mm

# STRUMENTI DI MARKETING



## ESPOSITORE SPIRIT PRO

16 plance

10 piastrelle

Costo: 350 euro

Dimensioni: 1540 x 2008 x 531 mm

# STRUMENTI DI MARKETING



## ESPOSITORE SPIRIT XL

8 plance

Costo: 150 euro

Dimensioni: 770 x 2008 x 450 mm



## **ESPOSITORE SPIRIT UNIVERSAL**

24 pannelli

**Costo set 24 pannelli: 180 euro**

**Costo espositore comprensivo di set 24 pannelli: 700 euro**

**Dimensioni: 1325 x 1700 x 740 mm**



## COLLEZIONE PURE



La collezione Pure sarà ancora disponibile. Ricordiamo che durante l'autunno 2018 l'intera collezione ha subito modifiche tecniche radicali che ne hanno ridefinito le prestazioni.

Nei prossimi mesi la collezione verrà rivista nei colori e sarà soggetta ad ulteriori migliorie tecniche.